



INDEX	PAGE(S)
Drawers for Shelving	118 - 119
Preconfigured Models . . .	120 - 121
Components	122 - 123
Accessories	124
Assembly and Security Recommendations . . .	125

MAXIMIZE USE OF SPACE

Say goodbye to poorly lit shelves, backaches and difficulty accessing materials caused by inadequate storage! Let us help you redesign your space.

As storage specialists, we recommend adding Rousseau drawers to your shelving units to maximize their potential. You will gain a hybrid and versatile system that has proved its effectiveness for over 30 years.

With their sturdy construction and distinctive design, Rousseau drawers add value to your existing equipment. Rousseau's modular drawers can be installed in over 35 brands of shelving on the market, so you can even keep your existing set-up. What's more, your new storage system can scale up or down in line with the needs of your business. A simple and economic solution; just imagine the possibilities!



LIFETIME WARRANTY

The Rousseau drawer rolling mechanism is covered by a lifetime warranty.

"Bringing Order To Chaos"

w.w.Cannon, Inc.

Design. Layout. Build. Install.

1-800-442-3061
www.wwcannon.com

"Bringing Order To Chaos"

THE ROUSSEAU DIFFERENCE

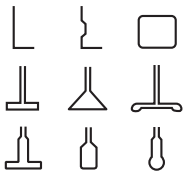

The drawers can also be installed in over 35 brands of shelving available on the market. Quick and easy hook-on assembly in most brands of shelving.

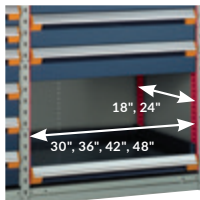

A range of dimensions available: 30\"/>



10 drawer heights and 7 drawer side heights available.

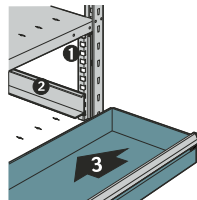

Quick and easy installation:
 1. Hook brackets on
 2. Hook rails on
 3. Insert carriages and drawers



400lb. load capacity per drawer. Most durable drawer in the industry.

GENERAL DIMENSIONS



NOTE: Popular dimensions are shown in red.

RECLAIM EXISTING SPACE

Instead of building an addition, use high-density storage and optimize the investment you made in your original space.

Ask our expert consultants for a comprehensive analysis of your potential savings.

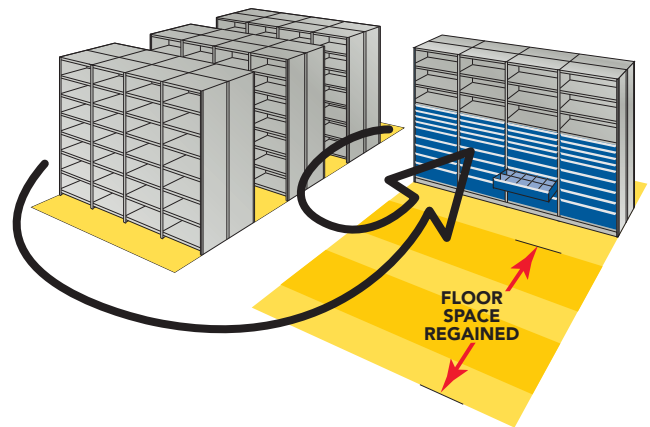
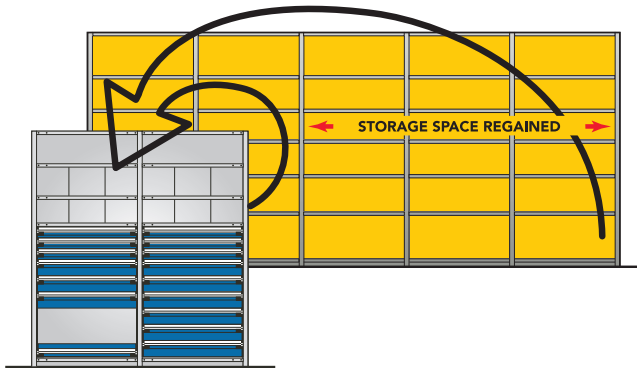

CURRENT SITUATION

- 1 Top and bottom shelves are not properly filled, nor accessible.
- 2 Back of shelves are poorly lit and visible.
- 3 Visibility of various items is hampered by the shelves.
- 4 Vast amount of unused space between shelves.

RESULT

Arduous management and location of your inventory.

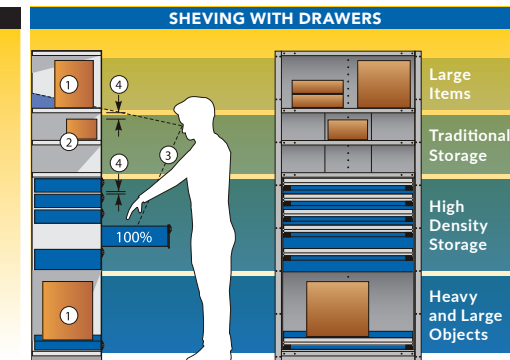
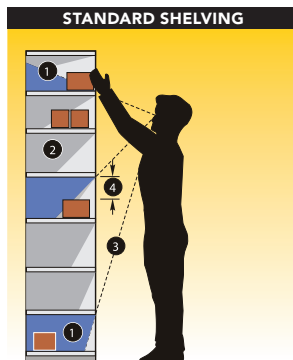

OUR RECOMMENDATIONS

- 1 Widely spaced shelves for the storage of larger items.
- 2 Close-set shelves positioned at eye-level.
- 3 Easily locate objects in a drawer that open's at 100%.
- 4 Optimized use of space based on the sizes of it's stored items.

RESULT

Easier management of your inventory based on an organized storage method.

PRECONFIGURED MODELS

HERE ARE SOME OF OUR MOST POPULAR PRECONFIGURED MODELS OF MODULAR DRAWERS FOR SHELVING

- Rousseau modular drawers can be installed in over 35 brands of commercially available shelving
- The preconfigured models in this section include brackets for Rousseau Spider® Shelving. For other types of shelving, please specify the brand and shelving type when ordering, see [page 123](#).

IMPORTANT

Drawer compartments are included in all models.

To order drawers without compartments, replace the last two digits of the model number with the next even number up.

e.g., R5LEC-1801 with
R5LEC-1802 without

Shelving with drawers must be anchored to the floor.



R5SEE-874811

DRAWER DIMENSIONS	NUMBER OF COMPARTMENTS (LAYOUT CODE)					
	36"W x 18"D	36"W x 24"D	42"W x 18"D	42"W x 24"D	48"W x 18"D	48"W x 24"D
3"H to 5"H	24 (0518)	30 (0524)	20 (0512)	30 (0524)	32 (0724)	40 (0732)
6"H to 8"H	8 (0304)	12 (0308)	12 (0308)	12 (0308)	10 (0405)	15 (0410)
9"H and higher	6 (0203)	9 (0206)	6 (0203)	8 (0304)	8 (0304)	8 (0304)

NOTE: For interior drawer dimensions, see [pages 206-208](#).
Shelving units must be ordered separately, see [pages 91-94](#).

18"H BANK OF DRAWERS FOR SHELVING



R5LEE-1801

- 4 drawers :
 - 3 drawers, 4"H
 - 1 drawer, 6"H

PRODUCT NO.	W x D
R5LEC-1801	36"W x 18"D
R5LEE-1801	36"W x 24"D
R5LGC-1801	42"W x 18"D
R5LGE-1801	42"W x 24"D
R5LHC-1801	48"W x 18"D
R5LHE-1801	48"W x 24"D

NOTE: Shelving units must be ordered separately.

24"H BANK OF DRAWERS FOR SHELVING



R5LEE-2401

- 5 drawers :
 - 3 drawers, 4"H
 - 2 drawers, 6"H

PRODUCT NO.	W x D
R5LEC-2401	36"W x 18"D
R5LEE-2401	36"W x 24"D
R5LGC-2401	42"W x 18"D
R5LGE-2401	42"W x 24"D
R5LHC-2401	48"W x 18"D
R5LHE-2401	48"W x 24"D

NOTE: Shelving units must be ordered separately.

36"H BANK OF DRAWERS FOR SHELVING



R5LEE-3601

- 7 drawers :
 - 3 drawers, 4"H
 - 4 drawers, 6"H

PRODUCT NO.	W x D
R5LEC-3601	36"W x 18"D
R5LEE-3601	36"W x 24"D
R5LGC-3601	42"W x 18"D
R5LGE-3601	42"W x 24"D
R5LHC-3601	48"W x 18"D
R5LHE-3601	48"W x 24"D

NOTE: Shelving units must be ordered separately.



R5LEE-3603

- 7 drawers :
 - 4 drawers, 4"H
 - 2 drawers, 6"H
 - 1 drawer, 8"H

PRODUCT NO.	W x D
R5LEC-3603	36"W x 18"D
R5LEE-3603	36"W x 24"D
R5LGC-3603	42"W x 18"D
R5LGE-3603	42"W x 24"D
R5LHC-3603	48"W x 18"D
R5LHE-3603	48"W x 24"D

NOTE: Shelving units must be ordered separately.

48" H BANK OF DRAWERS FOR SHELVING



R5LEE-4801

- 8 drawers :
 - 8 drawers, 6"H

PRODUCT NO.	W x D
R5LEC-4801	36"W x 18"D
R5LEE-4801	36"W x 24"D
R5LGC-4801	42"W x 18"D
R5LGE-4801	42"W x 24"D
R5LHC-4801	48"W x 18"D
R5LHE-4801	48"W x 24"D

NOTE: Shelving units must be ordered separately.



R5LEE-4803

- 9 drawers :
 - 4 drawers, 4"H
 - 4 drawers, 6"H
 - 1 drawer, 8"H

PRODUCT NO.	W x D
R5LEC-4803	36"W x 18"D
R5LEE-4803	36"W x 24"D
R5LGC-4803	42"W x 18"D
R5LGE-4803	42"W x 24"D
R5LHC-4803	48"W x 18"D
R5LHE-4803	48"W x 24"D

NOTE: Shelving units must be ordered separately.



R5LEE-4805

- 10 drawers :
 - 6 drawers, 4"H
 - 4 drawers, 6"H

PRODUCT NO.	W x D
R5LEC-4805	36"W x 18"D
R5LEE-4805	36"W x 24"D
R5LGC-4805	42"W x 18"D
R5LGE-4805	42"W x 24"D
R5LHC-4805	48"W x 18"D
R5LHE-4805	48"W x 24"D

NOTE: Shelving units must be ordered separately.



R5LEE-4807

- 11 drawers :
 - 4 drawers, 3"H
 - 3 drawers, 4"H
 - 4 drawers, 6"H

PRODUCT NO.	W x D
R5LEC-4807	36"W x 18"D
R5LEE-4807	36"W x 24"D
R5LGC-4807	42"W x 18"D
R5LGE-4807	42"W x 24"D
R5LHC-4807	48"W x 18"D
R5LHE-4807	48"W x 24"D

NOTE: Shelving units must be ordered separately.



R5LEE-4809

- 7 drawers :
 - 2 drawers, 3"H
 - 3 drawers, 4"H
 - 2 drawers, 6"H
- 1 front access roll-out shelf

PRODUCT NO.	W x D
R5LEC-4809	36"W x 18"D
R5LEE-4809	36"W x 24"D
R5LGC-4809	42"W x 18"D
R5LGE-4809	42"W x 24"D
R5LHC-4809	48"W x 18"D
R5LHE-4809	48"W x 24"D

NOTE: Shelving units must be ordered separately.



DRAWERS, SHELVES AND LOCKING/SECURITY MECHANISMS

HEAVY-DUTY MODULAR DRAWER

RF32 / RF36



- Painted steel drawer: RF32
- Drawer with stainless steel front and gray painted steel interior: RF36
- 400lb. load capacity, 100% extension
- Heavy-duty construction
- Easy to install
- Vast choice of accessories available to customize the drawer to your storage needs, [see pages 228-233](#);
- Drawer heights available: 3", 4", 5", 6", 7", 8", 9", 10", 12" and 14"
- For preconfigured modular drawer compartment layouts, [see pages 210-227](#);
- To order: Add the drawer height to the product number and specify the type of drawer front required (painted steel or stainless steel), e.g., RF32-362406

PRODUCT NO.	W x D
RF__-3018__	30"W x 18"D
RF__-3024__	30"W x 24"D
RF__-3618__	36"W x 18"D
RF__-3624__	36"W x 24"D
RF__-4218__	42"W x 18"D
RF__-4224__	42"W x 24"D
RF__-4818__	48"W x 18"D
RF__-4824__	48"W x 24"D

HEAVY-DUTY 3-SIDED-ACCESS ROLL-OUT SHELF

RF45



- 400lb. load capacity, 100% extension
- Heavy-duty construction
- Easy to install
- Galvanized steel with 1½"H back edge
- Total height: 5"
- Can be used as a work surface

PRODUCT NO.	W x D
RF45-3018	30"W x 18"D
RF45-3024	30"W x 24"D
RF45-3618	36"W x 18"D
RF45-3624	36"W x 24"D
RF45-4218	42"W x 18"D
RF45-4224	42"W x 24"D
RF45-4818	48"W x 18"D
RF45-4824	48"W x 24"D

DRAWER LOCK

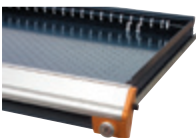

- Compatible with all drawer dimensions
- Does not reduce the drawer's storage space
- Easy to retrofit
- To order: Add L3 to the product number for the drawer or preconfigured compartment layout, e.g., RF32-362406L3
- For replacement parts or to retrofit this mechanism, order an RY01-L3



PRODUCT NO.
L3

HEAVY-DUTY FRONT-ACCESS ROLL-OUT SHELF

RF41



- 400lb. load capacity, 100% extension
- Heavy-duty construction
- Easy to install
- Painted steel with 3"H edges on the sides and back
- Total height: 6"
- Full access to contents

PRODUCT NO.	W x D
RF41-3018	30"W x 18"D
RF41-3024	30"W x 24"D
RF41-3618	36"W x 18"D
RF41-3624	36"W x 24"D
RF41-4218	42"W x 18"D
RF41-4224	42"W x 24"D
RF41-4818	48"W x 18"D
RF41-4824	48"W x 24"D

LOCK-OUT MECHANISM

RF85



- For both drawers and roll-out shelves
- Locks drawers and roll-out shelves in an open position
- Activated manually, only when required
- Compatible with all drawer accessories
- Plastic bins in the back row may make it more difficult to activate the mechanism

PRODUCT NO.
RF85

SECURITY PANEL

RF91

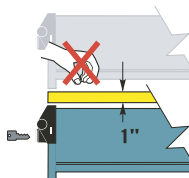

- Compatible with drawer locks
- Blocks access between two drawers or two banks of drawers
- Usable space in the bank of drawers is reduced by 1"
- Installs between two drawers

PRODUCT NO.	W x D
RF91-3018	30"W x 18"D
RF91-3024	30"W x 24"D
RF91-3618	36"W x 18"D
RF91-3624	36"W x 24"D
RF91-4218	42"W x 18"D
RF91-4224	42"W x 24"D
RF91-4818	48"W x 18"D
RF91-4824	48"W x 24"D



MOUNTING BRACKETS

STANDARD MOUNTING BRACKETS

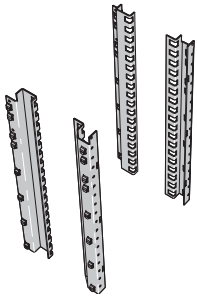

- Rousseau modular drawers can be installed in over 35 brands of commercially available shelving.
- Quick and easy hook-on assembly in most brands of shelving
 - Standard heights available: 18", 24", 36" and 48"
 - Mounting bracket kits are compatible with all Rousseau drawer widths (30", 36", 42" and 48")
 - Each kit includes two front and two rear mounting brackets and all hardware required
 - Includes holes spaced 1" apart c/c for easy adjustment of shelves
 - Two brackets can be stacked if a shelf is installed between them. The total height of the drawers must not exceed 60", e.g., 36"H + 18"H = 54"H (safe height), [see page 125](#)
 - To order non-standard mounting bracket heights, please contact Customer Service
 - To order: Complete the product number with the shelving brand code required, e.g., RE30-48 for Rousseau Spider® shelving

PRODUCT NO.	HEIGHT
RE__-18	18"
RE__-24	24"
RE__-36	36"
RE__-48	48"

SHELVING BRAND CODES		
COMPANY	BRAND	CODE
Adapto	Vector	RE45
Aurora	Quik-Lok	RE04
Bilt Industries	Klip-Bilt II	RE18
Borroughs	Steel Shelving	RE02
Easyup	7000	RE31
Equipto	V-Grip	RE29
EZ Rect	Trim Line	RE26
EZ Rect	Type I	RE14
Hallowell	Hi-Tech Shelving	RE07
Inca	Inca-matic	RE10
Lyon	8000	RE16
Metalware	Interlok	RE05
Penco	Clipper	RE08
Penco	Erectomatic	RE07
Republic	Clip Shelving	RE20
Rousseau	«O»	RE01
Rousseau	Spider®	RE30
Spacesaver	4-post Shelving	RE04
Tennsco	L&T Shelving	RE04
Tennsco	Q-Line	RE43
Tri-Boro	Steel Shelving	RE33
Triple A	600	RE27
Western Pacific	Clip Shelving	RE22
Western Pacific	Deluxe	RE24

EXAMPLES OF COMPATIBLE UPRIGHTS

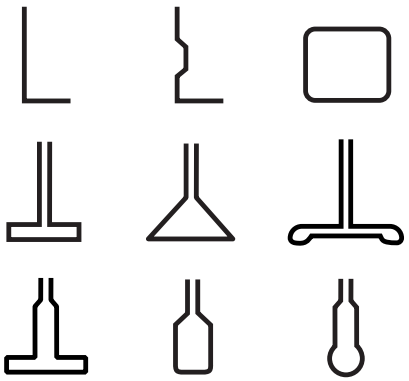

NOTES: Other mounting brackets are available. If your brand of shelving is not listed here, please contact Customer Service.
The brands listed are the property of their respective owners.

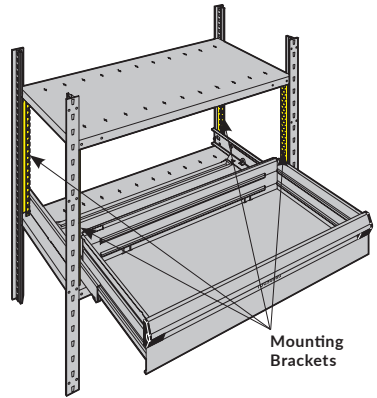

CUSTOM-ORDER MOUNTING BRACKETS

Rousseau can manufacture mounting brackets for new shelving upon request. Please contact Customer Service for more information.



VERTICAL SECURITY BAR

RE80



- Locks all drawers in a shelving unit with a key or padlock
- The key or safety hasp is located at the top of the bar to facilitate access
- Covers a bank of drawers from 18"H to 48"H
- Quick and easy hook-on assembly
- More than one bar on the same mounting bracket can be installed (for different users)
- Installs on the right-hand side
- The 36"H bar is compatible with the 34"H mounting bracket, and the 48"H bar is compatible with the 46"H mounting bracket
- Compatible with Rousseau Spider® shelving only. For Spacesaver shelving, order RE81-HHL3A instead of RE80-HHL3A
- To order: Specify the type of lock required, for a safety hasp, add LP to the product number; for a standard lock, add L3 to the product number



PRODUCT NO.	HEIGHT
RE80-18__A	18"
RE80-24__A	24"
RE80-30__A	30"
RE80-36__A	36"
RE80-48__A	48"

FILLER

RE90

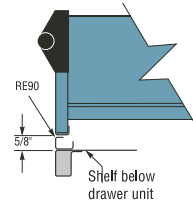

- Installs under the bank of drawers with an adhesive strip
- Fulfills aesthetic requirements of certain work environments (hospitals, offices, etc.)
- Compatible with Rousseau Spider® and Spacesaver shelving only
- For Spacesaver shelving, order RE90-WW02 instead of RE90-WW01

Product No.	W x H
RE90-3001	30"W x 3/4"H
RE90-3601	36"W x 3/4"H
RE90-4201	42"W x 3/4"H
RE90-4801	48"W x 3/4"H

NOTES: Other accessories for Spider® shelving are available in the Spider® Shelving System section, [see pages 79-86](#).
To lock drawers in all other brands of shelving, use the L3 Drawer Lock, [see page 122](#).

REAL-WORLD EXAMPLES

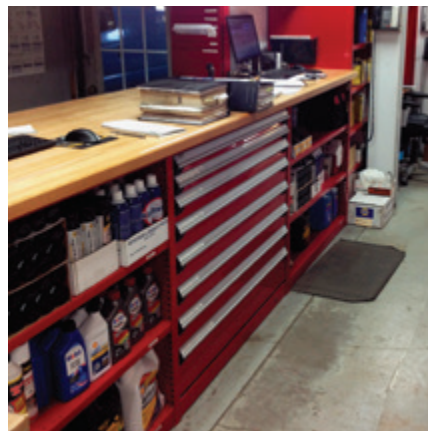
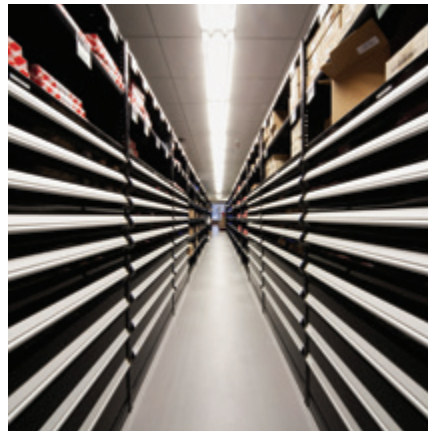

STACKING BRACKETS

Two sets of mounting brackets can be stacked if a shelf is installed between the two banks of drawers, e.g., 36"H + 18"H.

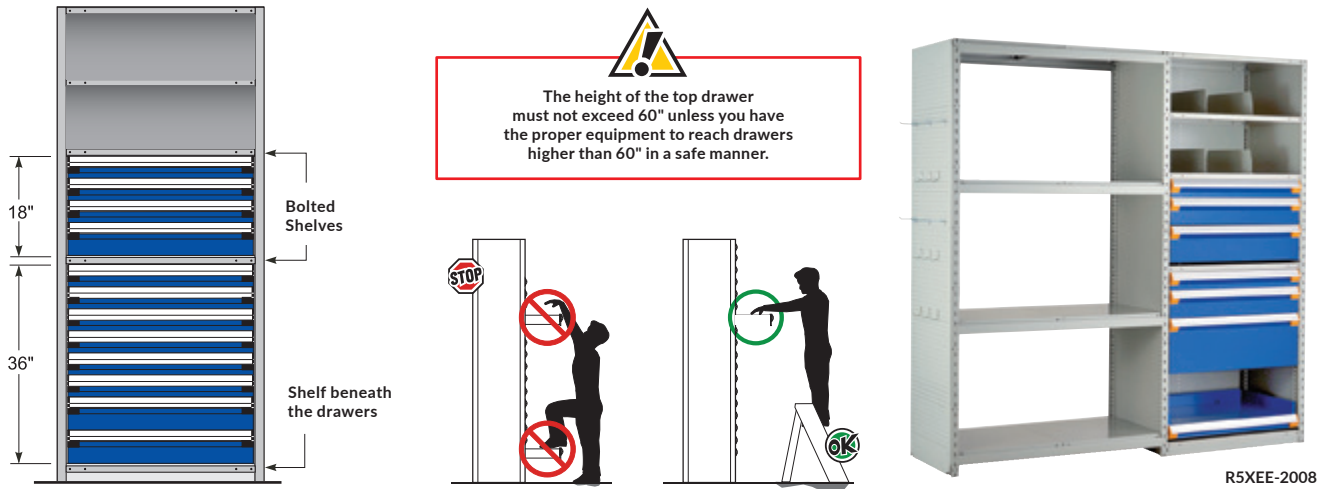

ASSEMBLY

Assemble with standard tools in three easy steps:

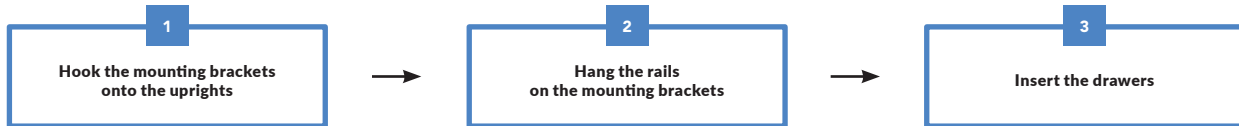

THE MINIMUM SPACE REQUIRED FOR DRAWERS DEPENDS ON THE HEIGHT OF THE MOUNTING BRACKETS.

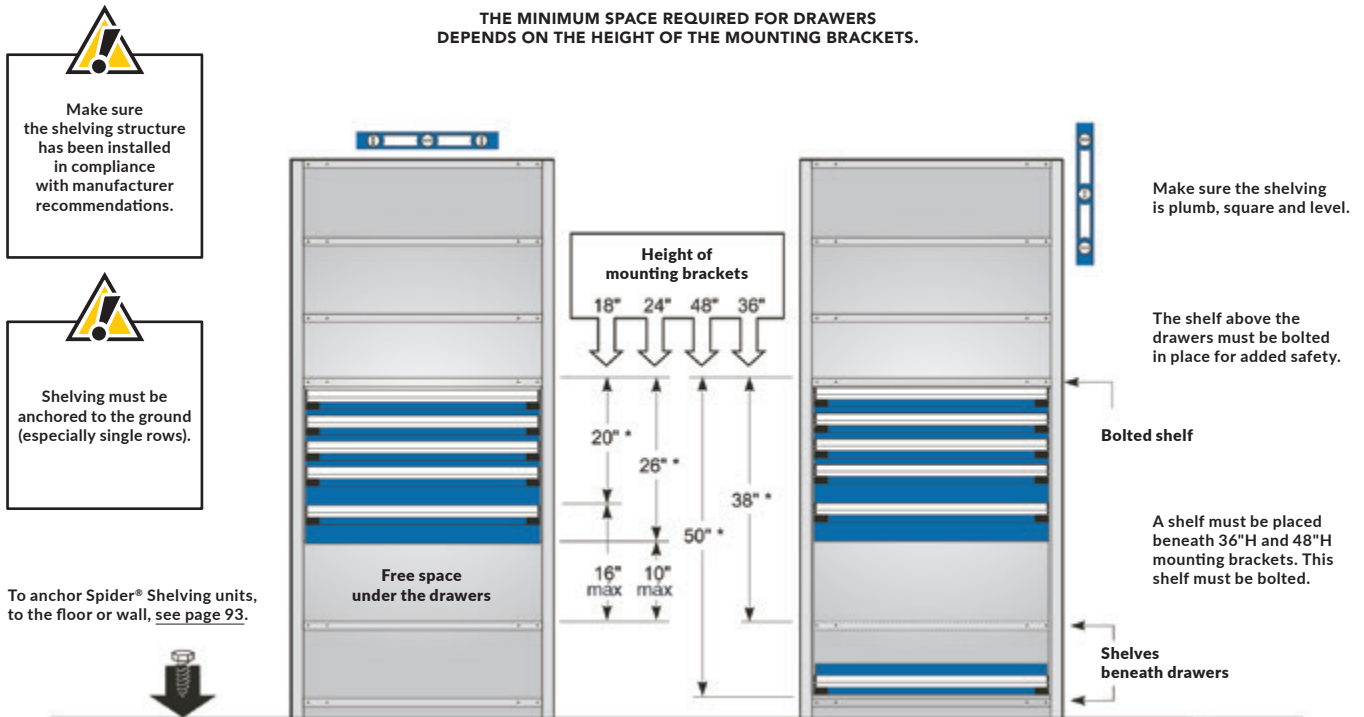

NOTE: * Subtract 1/2" for shelving with 1 1/2" adjustable shelves (c/c).